

INSTRUMENTS AND ACCESSORIES FOR APC

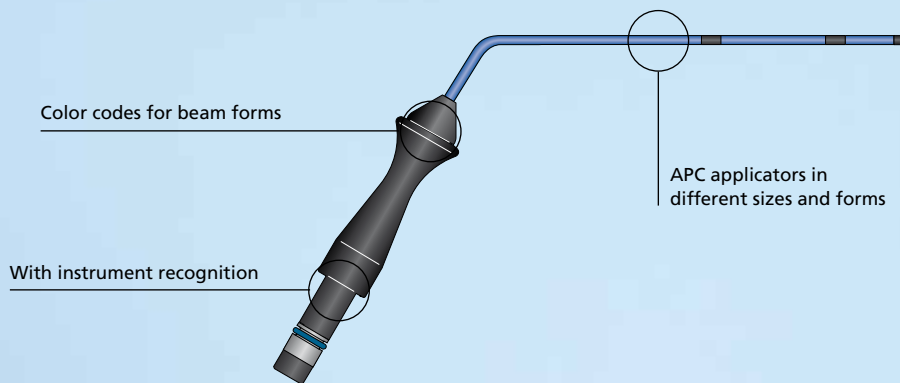
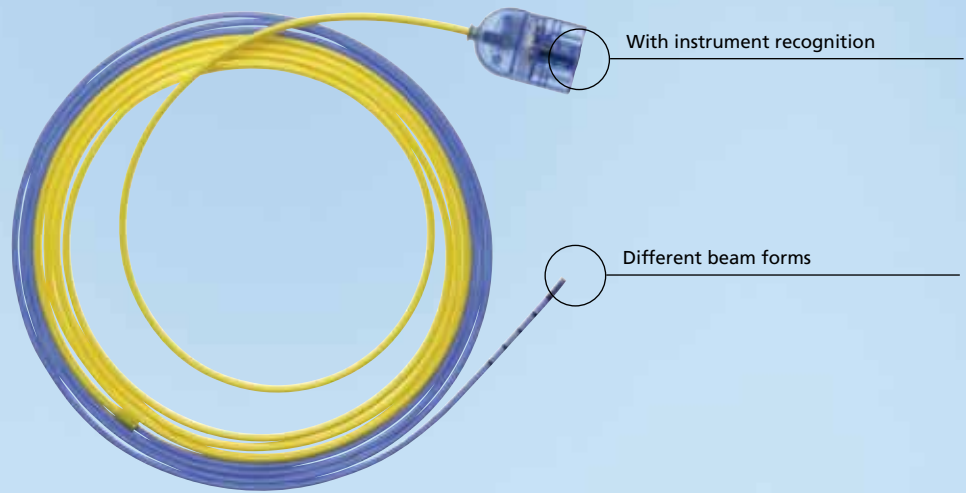

Important notes

The authors and ERBE Elektromedizin GmbH have taken the greatest possible care while compiling the catalogue with electrosurgical accessories. Nevertheless, it is impossible to exclude the possibility that errors may be contained herein.

The information and recommendations given here may not be construed as constituting any basis for any claims against ERBE Elektromedizin GmbH. Should legal regulations stipulate liability, such liability shall be limited to intentional misconduct or gross negligence.

The data on the use of instruments is based on clinical experience. Medical science is subject to a process of permanent change based on research and clinical experience. Therefore the products are subject to alterations in design and technique. Because of production tolerances dimensions in the catalogue may marginally differ.

We confirm that none of our products contain latex, except the rubber straps, Art. No. 20592-009 and 20592-011.

Please read carefully the corresponding notes on use before using any instrument.

Further product information

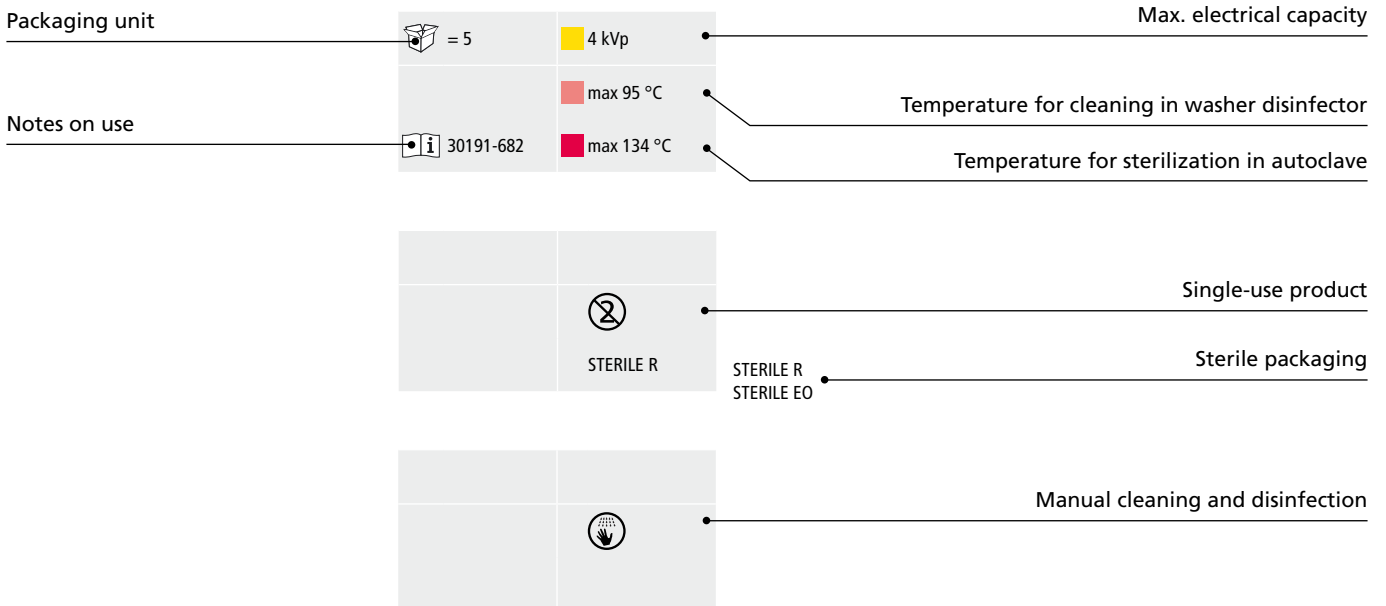

Argon plasma coagulation

Instruments for APC

FiAPC probes, single use	04
Flexible APC probes, reusable	07
Flexible APC probes, single use	09
APC applicators for APC connecting cables	11
APC applicators for APC handles	14

Accessories for APC

APC connecting cables	17
APC handles	18
APC irrigation adapters	19
APC ignition test adapters	19

Overview

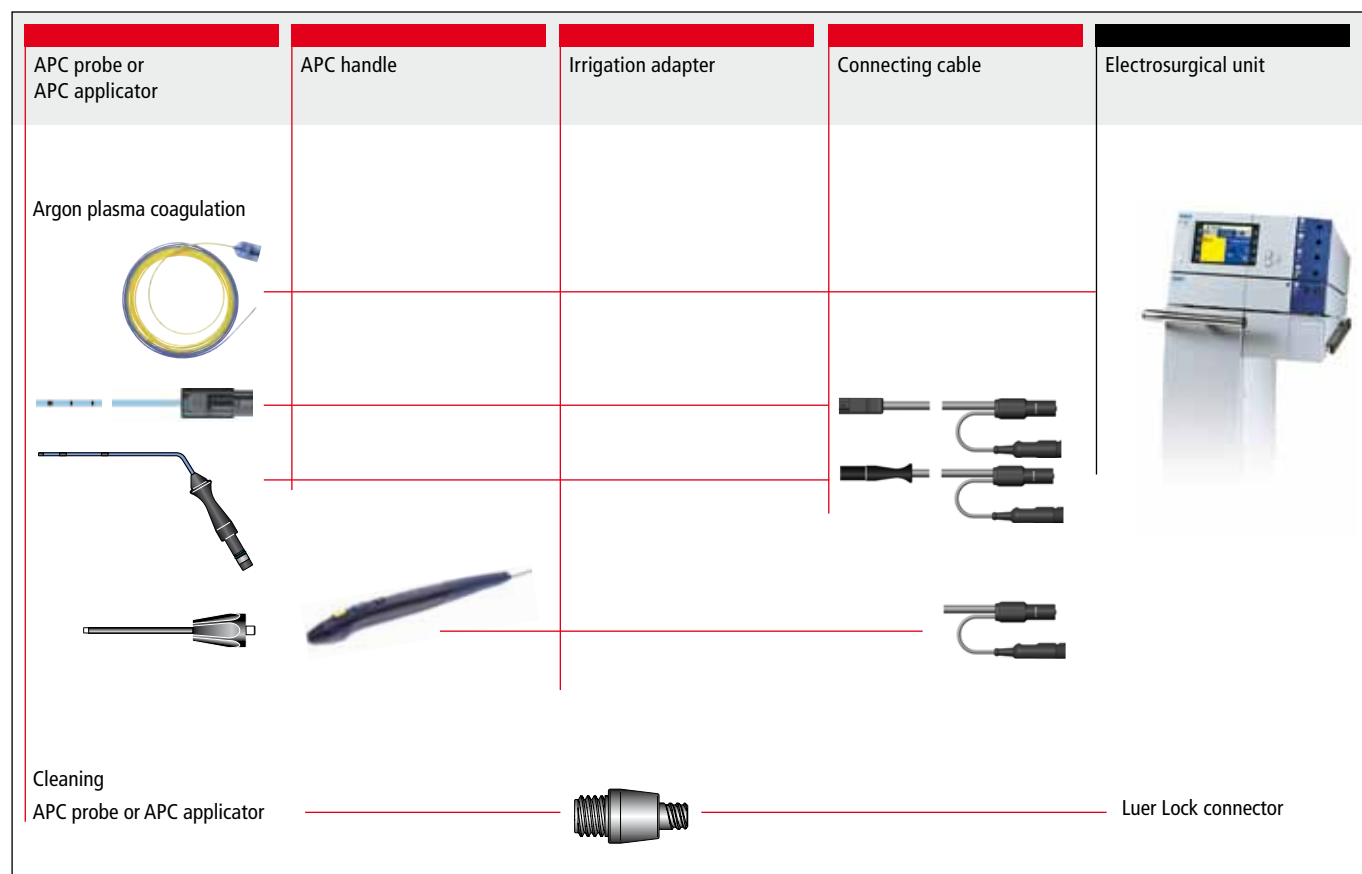

FiAPC probes, single use

Beam forms

Axial beam
A



Side Fire Wide Beam
SW

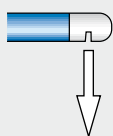

Side Fire Conical Beam
SC

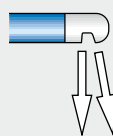

Circumferential Beam
C

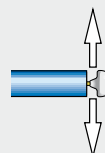

FiAPC probe 1500 A, Ø 1.5 mm, flexible, length 1.5 m

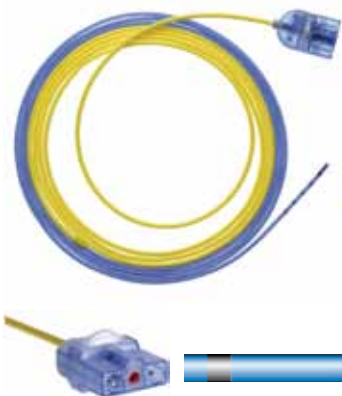

with instrument recognition and integrated filter,
e.g. for bronchoscopy

No. 20132-220

= 10

4.3 kVp

30132-344



STERILE EO

FiAPC probe 2200 A, Ø 2.3 mm, flexible, length 2.2 m

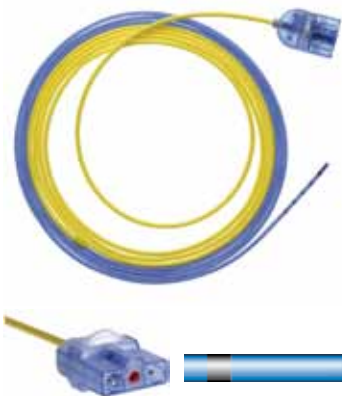

with instrument recognition and integrated filter

No. 20132-221

= 10

4.3 kVp

30132-344



STERILE EO

FiAPC probes, single use

FiAPC probe 2200 A, Ø 3.2 mm, flexible, length 2.2 m

with instrument recognition and integrated filter



No. 20132-222

= 10	4.3 kVp
30132-344	STERILE EO

FiAPC probe 3000 A, Ø 2.3 mm, flexible, length 3 m

with instrument recognition and integrated filter



No. 20132-223

= 10	4.3 kVp
30132-344	STERILE EO

FiAPC probe 2200 SC, Ø 2.3 mm, flexible, length 2.2 m

with instrument recognition and integrated filter



No. 20132-224

= 10	4.3 kVp
30132-344	STERILE EO

FiAPC probes, single use

FiAPC probe 2200 C, Ø 2.3 mm, flexible, length 2.2 m



with instrument recognition and integrated filter

No. 20132-225

= 10

4.3 kVp

30132-344



STERILE EO

FiAPC probe 3000 A, Ø 1.5 mm, flexible, length 3 m



with instrument recognition and integrated filter,
e.g. for double-balloon enteroscopy

No. 20132-226

= 10

4.3 kVp

30132-344



STERILE EO

Adapter for FiAPC probes



No. 20132-227

= 1

4.3 kVp

30132-346

max 95 °C

max 138 °C

Flexible APC probes, reusable

APC probe 1500 A, Ø 1.5 mm, flexible, length 1.5 m



with instrument recognition, e.g. for bronchoscopy

No. 20132-183

= 1	4 kVp
30132-326	max 95 °C
	max 138 °C

APC probe 1000 A, Ø 2.3 mm, flexible, length 1 m



with instrument recognition

No. 20132-178

= 1	4.3 kVp
30132-326	max 95 °C
	max 138 °C

APC probe 2200 A, Ø 2.3 mm, flexible, length 2.2 m



with instrument recognition

No. 20132-177

= 1	4.3 kVp
30132-326	max 95 °C
	max 138 °C

APC probe 3000 A, Ø 2.3 mm, flexible, length 3 m



with instrument recognition

No. 20132-179

= 1	4.3 kVp
30132-326	max 95 °C
	max 138 °C

APC probe 2200 SW, Ø 2.3 mm, flexible, length 2.2 m



with instrument recognition

No. 20132-180

= 1	4.3 kVp
30132-326	max 95 °C
	max 138 °C

Flexible APC probes, reusable

APC probe 2200 SC, Ø 2.3 mm, flexible, length 2.2 m



with instrument recognition

No. 20132-181



= 1

4.3 kVp

max 95 °C



30132-326

max 138 °C

APC probe 2200 A, Ø 3.2 mm, flexible, length 2.2 m



with instrument recognition

No. 20132-182



= 1

4.3 kVp

max 95 °C



30132-326

max 138 °C

APC connecting cable/irrigation adapter

Connecting cable for flexible APC probes, APC 2, APC 300



Length

2.5 m

No.

20132-158

Irrigation adapter for flexible APC probes to Luer Lock connector



20132-203

Bacteriological filter set, APC 2, APC 300, 0.2 µm, sterile

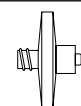

20132-059

Flexible APC probes, single use

APC probe 1500 A, Ø 1.5 mm, flexible, length 1.5 m



with instrument recognition, e.g. for bronchoscopy

No. 20132-155

= 10

4 kVp

30132-309



STERILE EO

APC probe 3000 A, Ø 1.5 mm, flexible, length 3 m



with instrument recognition,
e.g. for double-balloon enteroscopy

No. 20132-212

= 10

4 kVp

30132-309



STERILE EO

APC probe 2200 A, Ø 2.3 mm, flexible, length 2.2 m



with instrument recognition

No. 20132-156

= 10

4.3 kVp

30132-309



STERILE EO

APC probe 3000 A, Ø 2.3 mm, flexible, length 3 m



with instrument recognition

No. 20132-166

= 10

4.3 kVp

30132-309



STERILE EO

APC probe 2200 SC, Ø 2.3 mm, flexible, length 2.2 m



with instrument recognition

No. 20132-167

= 10

4.3 kVp

30132-309



STERILE EO

Instruments for APC

Flexible APC probes, single use

APC probe 2200 C, Ø 2.3 mm, flexible, length 2.2 m



with instrument recognition

No. 20132-186



= 10

4.3 kVp



30132-309



STERILE EO

APC probe 2200 A, Ø 3.2 mm, flexible, length 2.2 m



with instrument recognition

No. 20132-157



= 10

4.3 kVp



30132-309



STERILE EO

APC connecting cable and filter set

Connecting cable for flexible APC probes,
APC 2, APC 300



Length

2.5 m

No.

20132-158

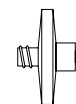

Bacteriological filter set, APC 2, APC 300,
0.2 µm, sterile



20132-059

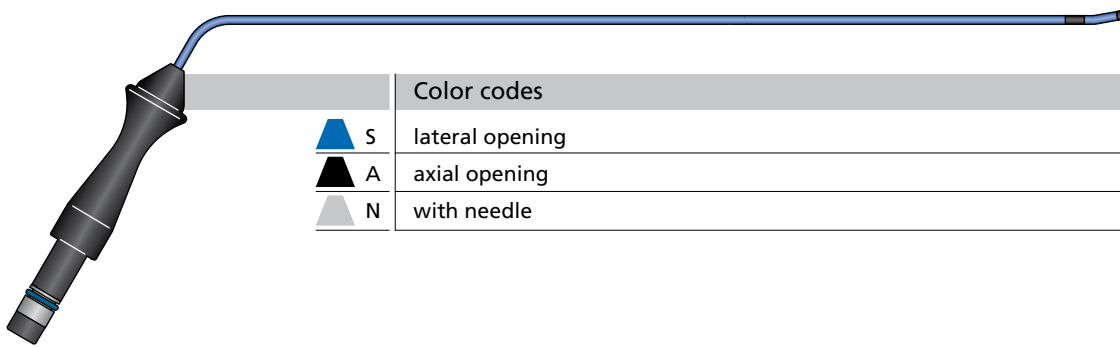



APC applicators for APC connecting cables

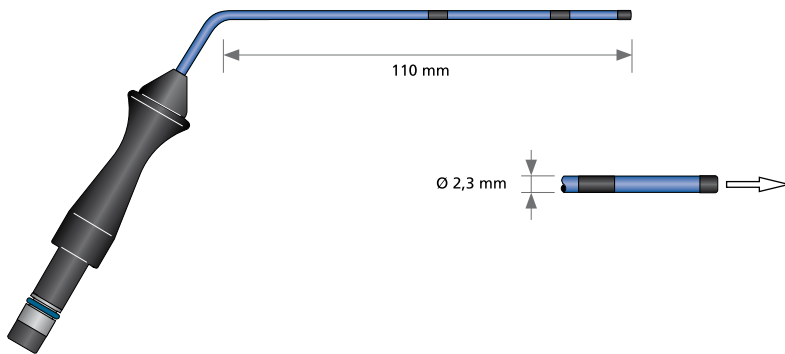

Color codes	
	S lateral opening
	A axial opening
	N with needle





APC applicator 110 A, Ø 2.3 mm, rigid, length 110 mm

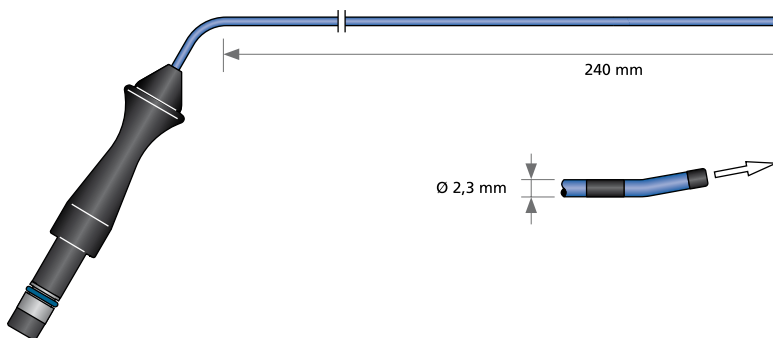

No. 20132-107	
 = 1	 4.3 kVp
	 max 95 °C
 30132-245	 max 138 °C





APC applicator 240 A, Ø 2.3 mm, rigid, length 240 mm

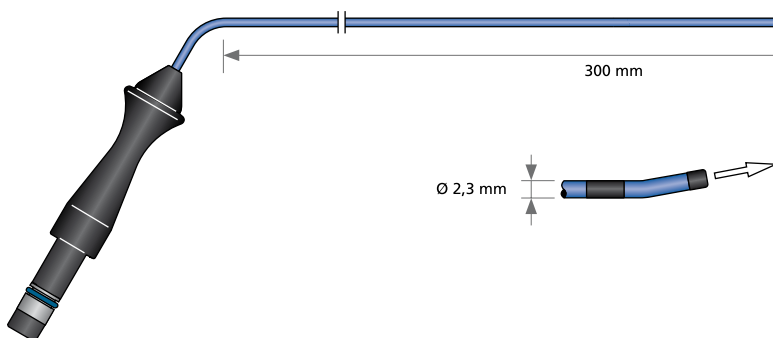

No. 20132-111	
 = 1	 4.3 kVp
	 max 95 °C
 30132-245	 max 138 °C

APC applicator 300 A, Ø 2.3 mm, rigid, length 300 mm



No. 20132-113	
 = 1	 4.3 kVp
	 max 95 °C
 30132-245	 max 138 °C

APC applicators for APC connecting cables

APC applicator 500 A, Ø 2.3 mm, rigid, length 500 mm

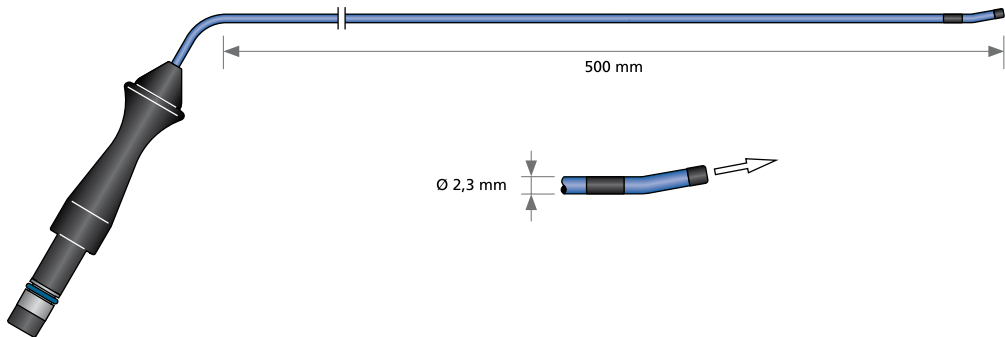

No. 20132-116



= 1

4.3 kVp

max 95 °C



30132-245

max 138 °C

APC applicator 110 SC, Ø 2.3 mm, rigid, length 110 mm

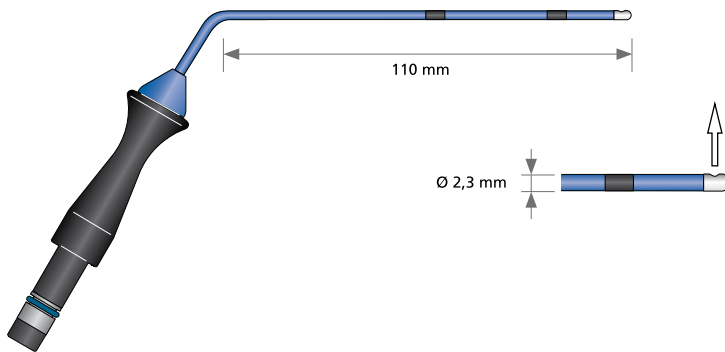

No. 20132-106



= 1

4.3 kVp

max 95 °C



30132-245

max 138 °C

Protection tongue for APC applicator 20132-106, elastic

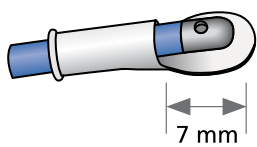

silicone

No. 20132-129



= 10

max 95 °C



30132-270

max 134 °C

APC applicator 240 S, Ø 2.3 mm, rigid, length 240 mm

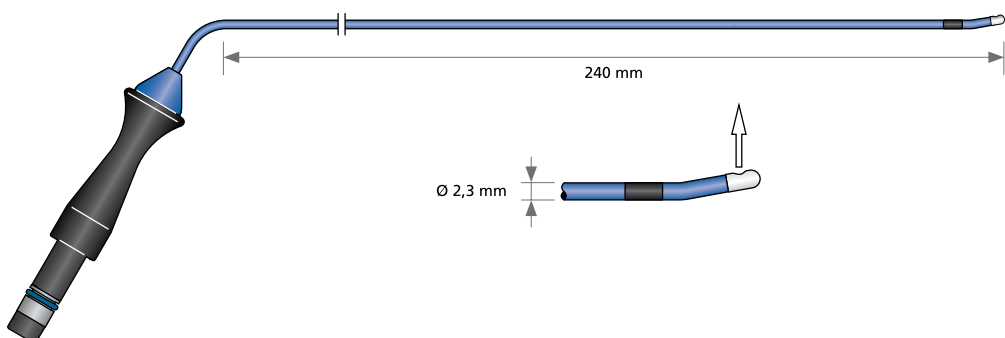

No. 20132-110



= 1

4.3 kVp

max 95 °C



30132-245

max 138 °C

APC applicators for APC connecting cables

APC applicator 110 N, Ø 2.3 mm, rigid, length 110 mm

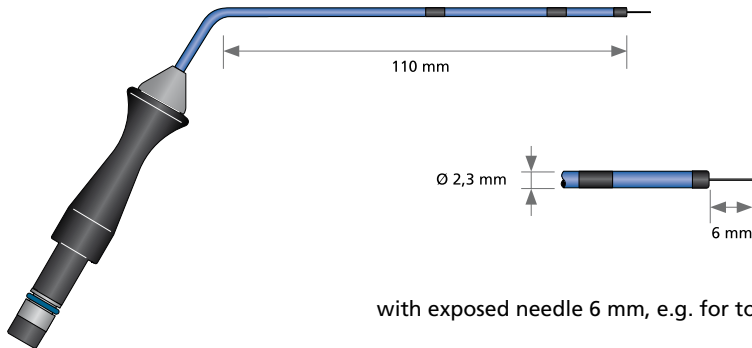

with exposed needle 6 mm, e.g. for tonsillectomy

No. 20132-109

= 1	4.3 kVp
	max 95 °C
30132-245	max 138 °C

APC applicator 116 SC, Ø 2.3 mm, rigid, length 116 mm

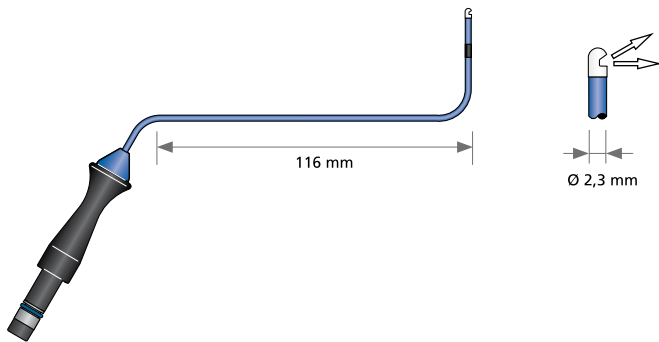

No. 20132-126

= 1	4.3 kVp
	max 95 °C
30132-245	max 138 °C

APC connecting cable/irrigation adapter		Length	No.
Connecting cable for APC applicators, APC 2, APC 300		2.5 m	20132-046
Irrigation adapter for APC applicators with Luer Lock			20132-095